

# MONOROTAIE E CARRELLI

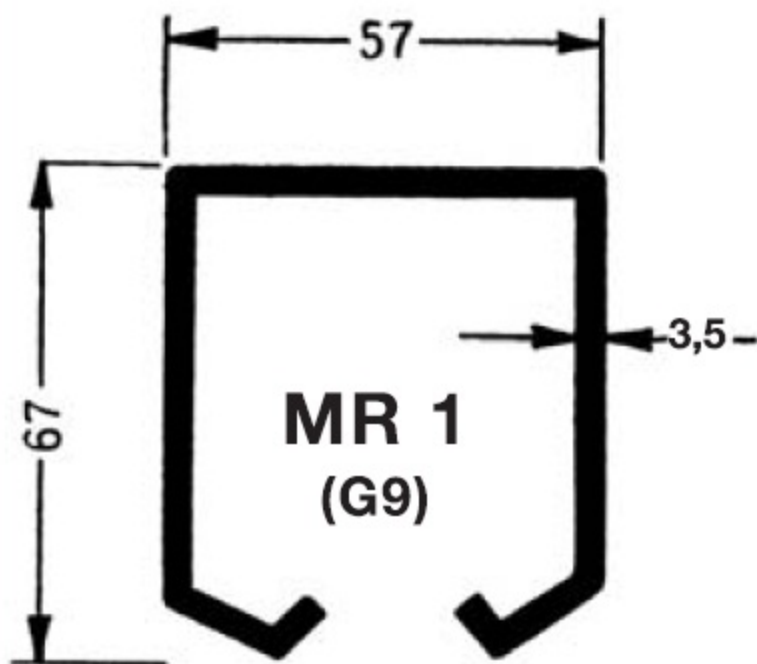

Tipo per carrelli grandi  
peso al m kg 5,000

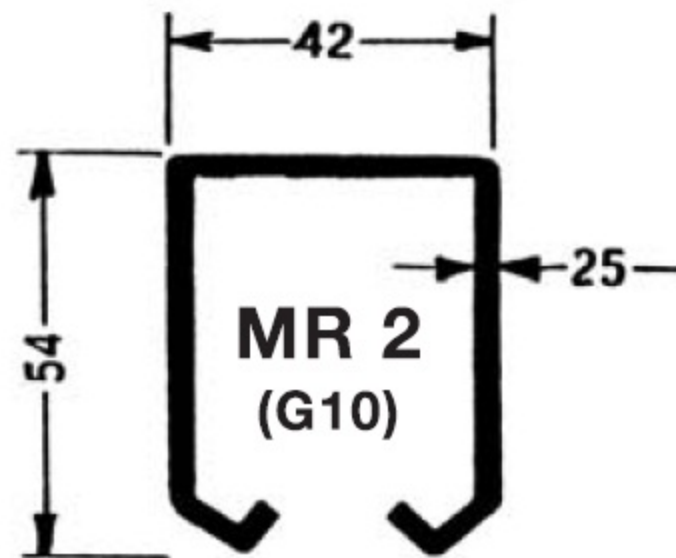

Tipo per carrelli piccoli  
peso al m kg 3,180

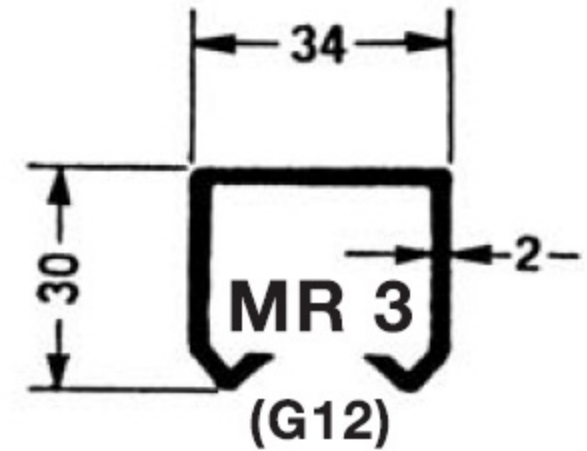

Tipo per carrelli mignon  
peso al m kg 1,774

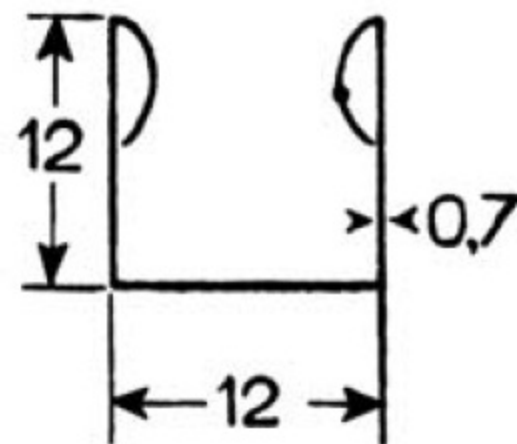
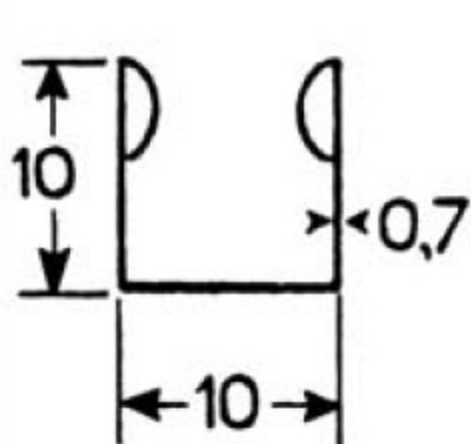

FERMAVETRO A SCATTO  
LUCIDO E ZINCATO

peso m kg 0,203    peso m kg 0,240  
spessore m / m 0,7

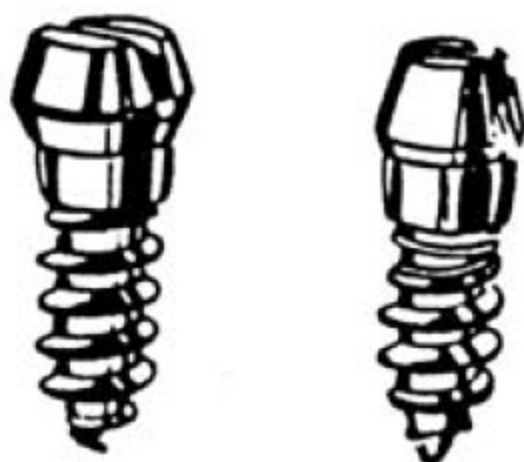

Viti in plastica e zincate autofilettanti  
per fermavetri a scatto  
per tipi 10 - 12

# CARRELLI per MONOROTAIE

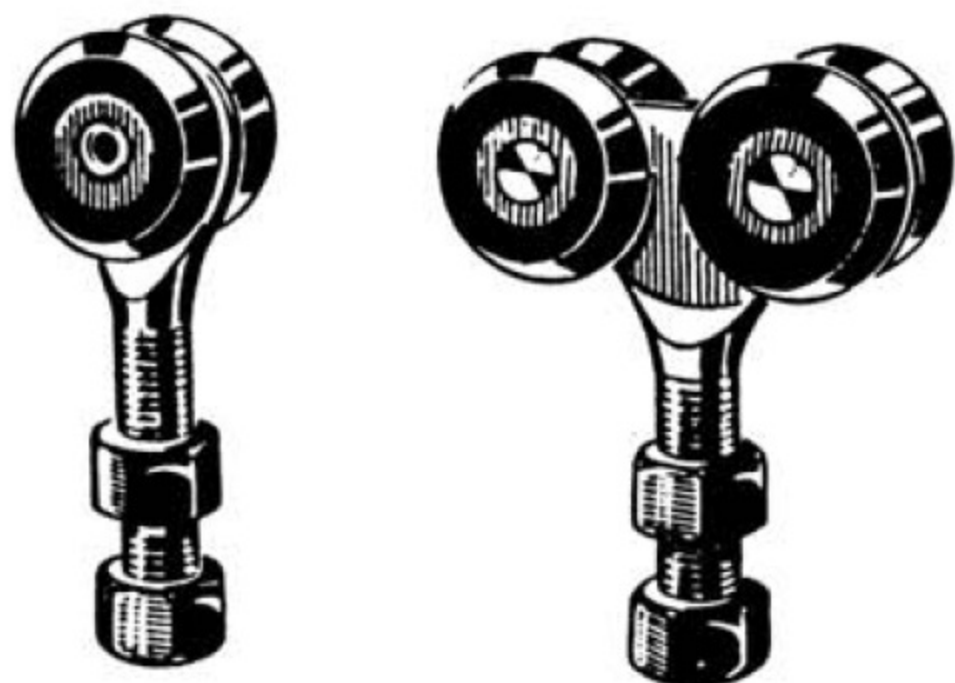

PORTATA MONOROTAIE  
(con supporto ogni metro)

Carrelli grandi e piccoli a 2 e 4 ruote

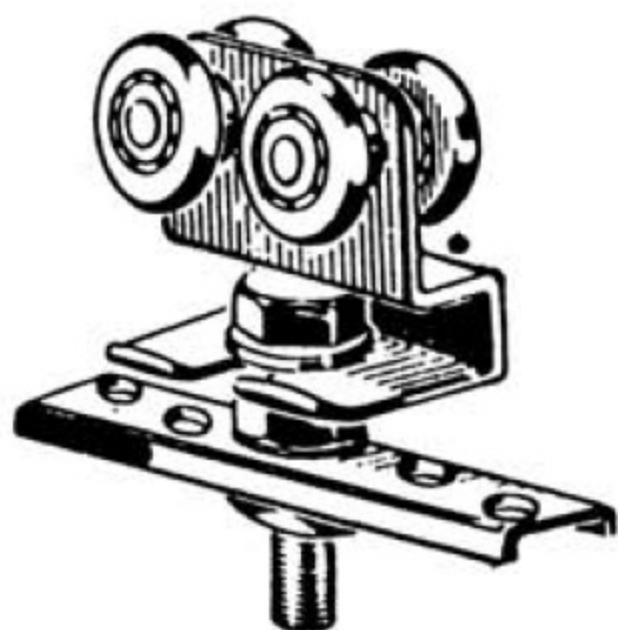

Carrelli Mignon a 4 ruote per MR 3

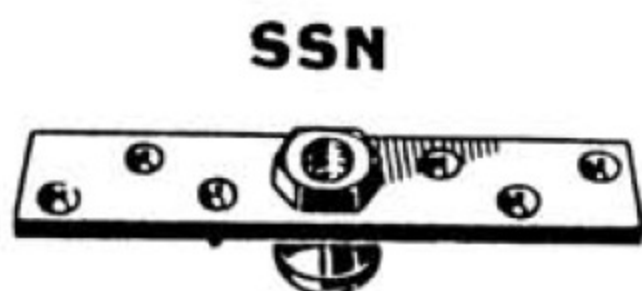

**SSN**

STAFFA SNODATA  
per carrelli ns / tipi  
MR 1  
MR 2



**GI**

GUIDA INFERIORE  
ad oliva con rullo ottone  
Ø 15  
Ø 25

# GUIDA ROLLING A PAVIMENTO

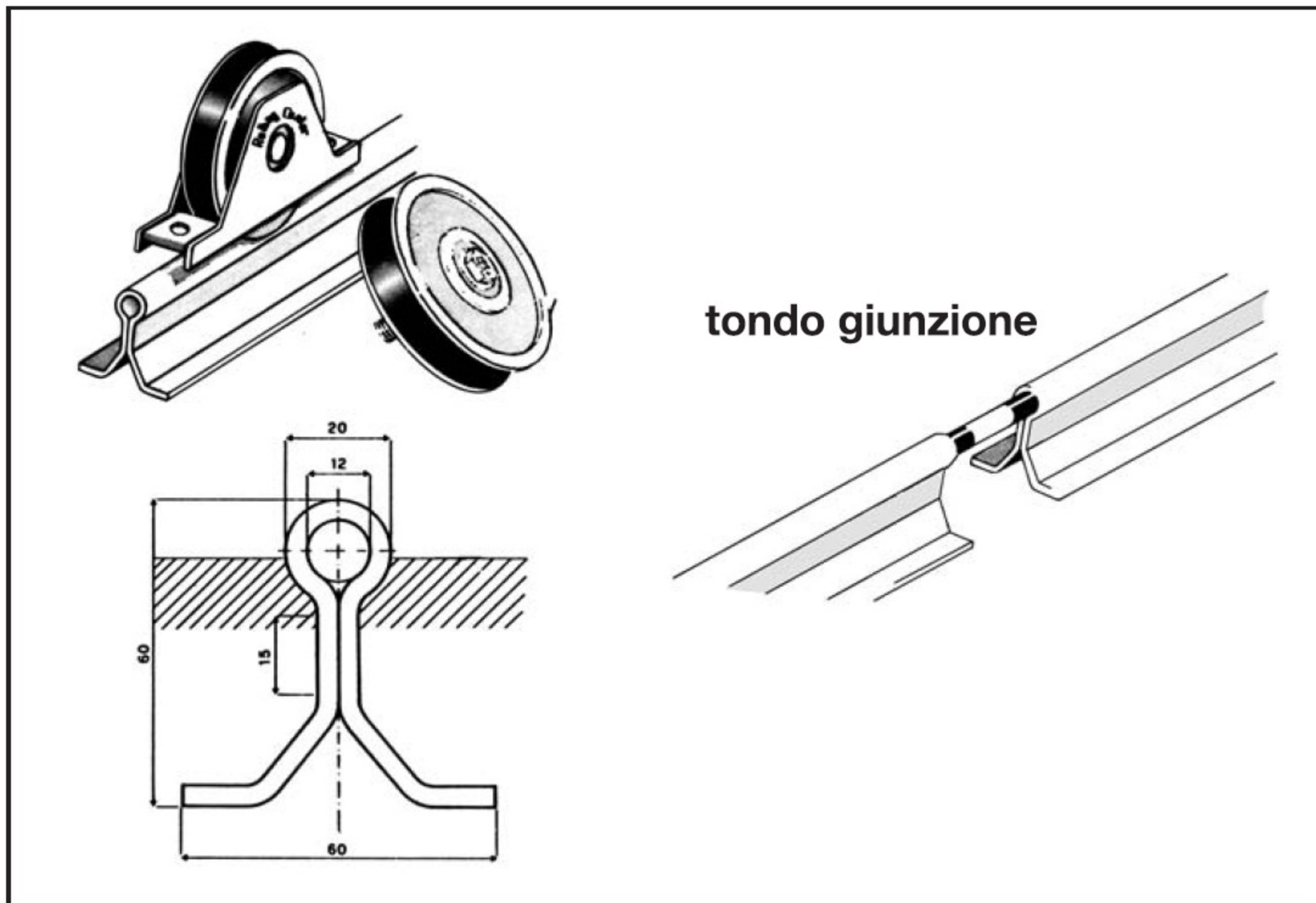

# GUIDA A PAVIMENTO TASSELLARE

